

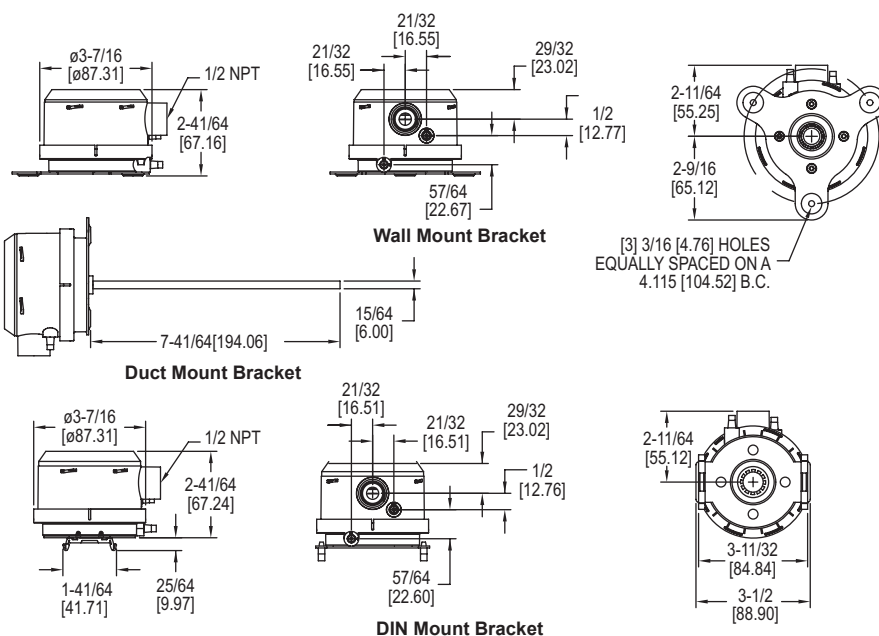

# Series MS2 Magnesense® II Differential Pressure Transmitter

## Specifications - Installation and Operating Instructions



The **Series MS2 Magnesense® II Differential Pressure Transmitter** combines the proven stable Piezo sensing technology of our original Series MS with additional features to reduce installation time and simplify ordering. In this second generation transmitter, we have added additional field selectable pressure ranges so that each model can have four selectable ranges along with four additional bidirectional ranges. When using the pluggable integral display or the portable remote display tool, both Metric and English engineering units can be selected via on board dip switches. Dual current and voltage outputs allow users to simultaneously take either a current or voltage output to their building controller and have a local test circuit for verification of the output reading. The voltage output can be selected to be either 0 to 5 VDC or 0 to 10 VDC, while the current is always 4 to 20 mA. Both the current and voltage output can also be inverted. Alternatively, the MS2 can be ordered with either a BACnet or MODBUS® Communications protocol that will allow the transmitters to be daisy-chained together.

Like the original Series MS, the second generation transmitter can be used as a linear pressure output or a linear velocity output with the square root extraction done in the transmitter. Additional parameters have been included to expand the square root capability to include flow measurements.

BACnet® and Modbus® Communications protocol recommend limiting the number of nodes in any segment to 32. Therefore, the transceiver may be rated at one unit load. Fractional loads are also acceptable. The MS2 accounts as an eighth of a load on the MSTP network.

### INSTALLATION

#### Surface Mount:

The transmitter should be mounted on a vertical surface with the connections directed down to prevent moisture from entering either the pressure ports or the electrical cable entry. The diaphragm must be vertical to minimize gravity effects on the diaphragm. Attach the mounting flange to a flat surface using three #8 x 1/2" pan head sheet metal screws. Do not over tighten.

#### Duct Mount:

The transmitter should be mounted away from fans, corners, heating and cooling coils and other equipment that will effect the measurement of the pressure.

- To mount the transmitter, drill a .562" (12.70 mm) diameter hold into the duct.
- Insert transmitter probe into the duct.
- Mark location of three mounting holes on duct using mounting flange as template. Drill holes.
- Attach mounting flange to duct with three #8 x 1/2" pan head sheet metal screws. Do not over tighten screws.

### SPECIFICATIONS

**Supported Baud Rates:** 9600, 19200, 38400, 57600, 76800, 115200.

**Data Size:** 8.

**Parity:** None.

**Stop Bits:** 1.

**Service:** Air and non-combustible, compatible gases.

**Wetted Materials:** Consult factory.

**Accuracy:**  $\pm 1\%$  FS for 0.25" (50 Pa), 0.5" (100 Pa), 2" (500 Pa), 5" (1250 Pa), 10" (2 kPa), 15" (3 kPa), 25" (5 kPa);  $\pm 2\%$  FS for 0.1" (25 Pa), 1" (250 Pa),  $\pm 0.1"$  ( $\pm 25$  Pa),  $\pm 1"$  ( $\pm 250$  Pa) and all bi-directional ranges.

**Stability:**  $\pm 1\%$  / year FSO.

**Temperature Limits:** 0 to 150°F (-18 to 66°C).

**Pressure Limits:** 1 psi max., operation; 10 psi burst.

**Power Requirements:** 10 to 35 VDC (2 wire), 17 to 36 VDC or isolated 21.6 to 33 VAC (3 wire).

**Output Signals:** 4 to 20 mA (2-wire), 0 to 5 VDC, 0 to 10 VDC (3-wire).

**Response Time:** Averaging 0 to 240 sec, 2.5 Hz sample rate, 1.5 to 228 sec for 95% step change.

**Zero & Span Adjustments:** Digital push buttons.

**Loop Resistance:** Current output: 0 to 1250Ω max; Voltage output: Min. load resistance 1kΩ.

**Current Consumption:** 40 mA max.

**Display (optional):** 5-digit LCD.

**Electrical Connections:** 3-wire removable European style terminal block for 16 to 26 AWG.

**Electrical Entry:** 1/2" NPS thread; Accessory (A-151): Cable gland for 5 to 10 mm diameter cable.

**Process Connection:** 3/16" ID tubing (5 mm ID); Max. OD 9 mm.

**Enclosure Rating:** IP66.

**Mounting Orientation:** Diaphragm in vertical position.

**Weight:** 8.0 oz (230 g).

**Agency Approvals:** CE.

#### Electrical Connection:

The Series MS2 simultaneously transmits a 2-wire 4 to 20 mA current output and a 3-wire 0 to 5 V / 0 to 10 V voltage output via a removable European-style three conductor terminal block. The transmitter can be wired in one of the following three ways to utilize the current and / or voltage output. The range of the voltage output can be selected using the on board dip switches as described in the Dip Switch Settings section of this manual.

Modbus® is a registered trademark of Schneider Automation, Inc.

**DWYER INSTRUMENTS, INC.**

P.O. BOX 373 • MICHIGAN CITY, INDIANA 46360, U.S.A.

Phone: 219/879-8000

Fax: 219/872-9057

www.dwyer-inst.com

e-mail: info@dwyermail.com

## Power Supply

Refer to the below table for the required supply rating.

Output Type	Power Supply Rating
2-wire current	10 to 40 VDC (40 mA min)
3-wire voltage	17 to 40 VDC or 21.6 to 33 VAC (40 mA min)
Simultaneous current and voltage	17 to 40 VDC (40 mA min)

Choose a power supply with a voltage and current rating sufficient to meet the power specifications under all operating conditions. If the supply is unregulated, make sure that the output voltage remains within the required voltage range under all power line conditions. Ripple on the supply should not exceed 100 mV.

## AC/DC Jumper Selection

**NOTICE** The jumper is factory set to AC. If DC power is applied while the jumper is set to AC, no damage will occur. However, the accuracy of the unit may temporarily be affected.

**CAUTION** Powering the unit with AC power while the jumper is set to DC may permanently damage the transmitter.

Refer to Figure 1 for the location of the AC / DC jumper. Place the shorting jumper across either the two pins marked AC or the two pins marked DC.

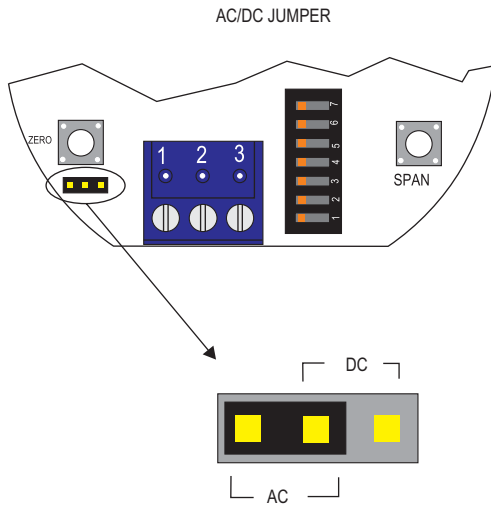
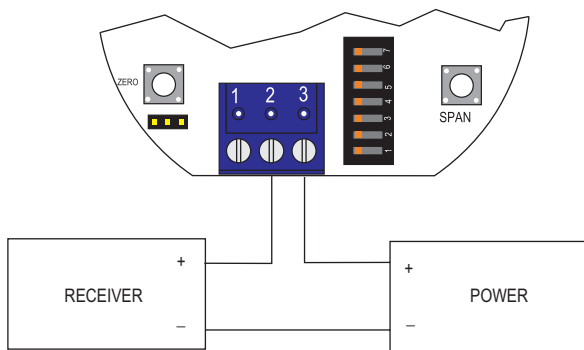

Figure 1

## 2-Wire 4 to 20 mA Current Operation

**CAUTION** DO NOT EXCEED SPECIFIED SUPPLY VOLTAGE RATINGS. PERMANENT DAMAGE NOT COVERED BY WARRANTY WILL RESULT. SIMULTANEOUS OUTPUTS ARE NOT DESIGNED FOR AC VOLTAGE OPERATION.

The connections to the transmitter are made through terminals 2 and 3 on the terminal block as shown in Figure 2. The terminal block is removable and each of the terminals are labeled underneath the terminal block on the circuit board. Polarity is indicated by +IOUT and -IOUT. The AC/DC selection jumper should be set for DC operation.



CURRENT OUTPUT WIRING

Figure 2

The range of appropriate receiver load resistances (RL) for the power supply voltage available is given by the formula listed below. Shielded 2-wire cable is recommended for control loop wiring. Ground the shield at the power supply end only.

**NOTICE** The receiver may be connected to either the negative or positive side of the loop, whichever is most convenient. Should polarity of the transmitter or receiver be inadvertently reversed, the loop will not function properly but no damage will be done to the transmitter.

$$R_L = \frac{V_{ps} - 10.0}{20 \text{ mA DC}}$$

The maximum length of connecting wire between the transmitter and the receiver is a function of wire size and receiver resistance. That portion of the total current loop resistance represented by the resistance of the connecting wires themselves should not exceed 10% of the receiver resistance. For extremely long runs (over 1,000 feet), it is desirable to select receivers with lower resistances in order to keep the size and cost of the connecting leads as low as possible. In installations where the connecting run is no more than 100 feet, connecting lead wire as small as No. 22 ga. can be used.

## 3-Wire 0 to 10 V and 0 to 5V Voltage Operation

**CAUTION** DO NOT EXCEED SPECIFIED SUPPLY VOLTAGE RATINGS. PERMANENT DAMAGE NOT COVERED BY WARRANTY WILL RESULT.

The connection to the transmitter are made to Terminals 1, 2, and 3 on the terminal block as shown in Figure 3. The terminal block is removable and each of the terminals are labeled underneath the terminal block on the circuit board. Polarity is indicated by PWR, COM, and +VOUT. When connecting using a DC power source, make sure the AC/DC selection jumper is set for DC. If the polarity of the transmitter is inadvertently reversed, the unit will not function properly, but no damage will be done to the transmitter. When connecting to an AC power source, make sure the AC/DC selection jumper is set for AC. Either lead of the supply power may be connected to PWR and COM without affecting the operation of the transmitter or damage to the transmitter.

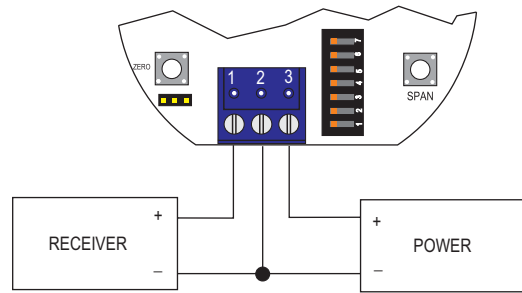

VOLTAGE OUTPUT WIRING

Figure 3

The minimum receiver load is 1K Ω. The resistance due to the wire should be low compared to the receiver load resistance. While the voltage at the terminal block remains unchanged with a 10 mA current flow, resistive losses in the wiring do cause errors in the voltage delivered to the receiver. For a 1% accurate gauge, the resistance of the wires should be less than 0.1% of the value of the receiver load resistance. This will keep the error caused by the current flow below 0.1%.

The output across +VOUT and COM will be either 0 to 5 V, 0 to 10 V, or the inverse depending on the dip switch setting. See Dip Switch Setting Section for more information.

## Simultaneous Current and Voltage Operation

### CAUTION

DO NOT EXCEED SPECIFIED SUPPLY VOLTAGE RATINGS. PERMANENT DAMAGE NOT COVERED BY WARRANTY WILL RESULT. SIMULTANEOUS OUTPUTS ARE NOT DESIGNED FOR AC VOLTAGE OPERATION.

The connection to the transmitter are made to Terminals 1, 2, and 3 on the terminal block as shown in Figure 4. The terminal block is removable and each of the terminals are labeled underneath the terminal block on the circuit board. Polarity is indicated by PWR, COM, and +VOUT. The AC/DC selection jumper should be set for DC operation. The voltage output and the power supply must have separate wire leads that are only joined at terminal 2 of the transmitter. Additional error may occur for the voltage output if a single wire is used or if the wires are joined at the power supply or receiver.

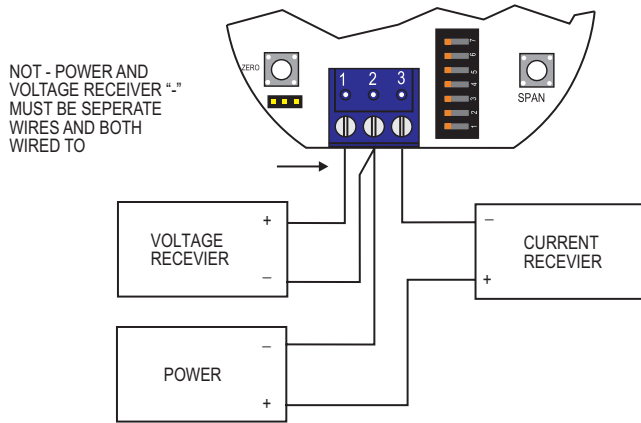

SIMULTANEOUS CURRENT AND VOLTAGE OUTPUT WIRING

Figure 4

For the current output, the maximum allowable loop resistance (wiring + receiver resistance) is dependent on the power supply. The maximum loop voltage drop must not reduce the transmitter voltage below 17 V. The maximum loop resistance can be calculated using the following equation:

$$R_{MAX} = (VPS - 17.0) / 0.02 \text{ Where VPS is the power supply voltage}$$

The equation uses 17.0 instead of 10.0 used in current only equation. This represents the minimum voltage supply which is higher on the simultaneous output configuration due to the requirements of the voltage outputs.

Shielded 4-wire cable is recommended for control loop wiring. Ground the shield at the power supply end only. Should the polarity of the transmitter or receiver be inadvertently reversed, the unit will not function properly, but no damage will be done to the transmitter.

For voltage outputs, the minimum receiver load is 1K  $\Omega$ . The resistance due to the wire should be low compared to the receiver load resistance. While the voltage at the terminal block remains unchanged with a 10 mA current flow, resistive losses in the wiring do cause errors in the voltage delivered to the receiver. For a 1% accurate gauge, the resistance of the wires should be less than 0.1% of the value of the receiver load resistance. This will keep the error caused by the current flow below 0.1%.

The output across +VOUT and COM will be either 0 to 5 V, 0 to 10 V, or the inverse depending on the dip switch setting. See Dip Switch Setting Section for more information.

## DIP SWITCH SETTINGS

DIP Switches can be located next to the terminal block as shown in Figure 5. A small screw driver or pen can be used to change the position of the switches.

### WARNING

All power should be turned off to the transmitter before adjusting the dip switch settings to avoid electrical shock.

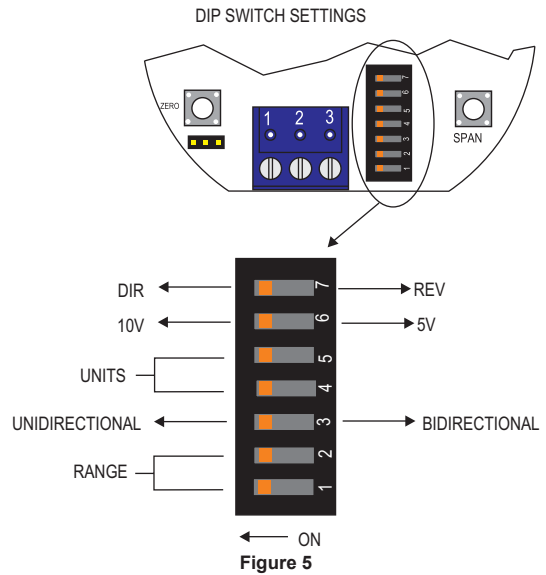

Figure 5

### Factory Settings

Mode = Unidirectional (except on MS2-XX1X models)  
 Range = Highest Range Setting (0.5, 5, or 28 in w.c.)  
 Units = Inches W.C.  
 Voltage Output Range = 10 V  
 Direct / Reverse Output Action = Direct

### Setting the Pressure Range

Ranges are selected by adjusting DIP Switch Positions 1 and 2 according to the below tables. The range also depends on the units selected (Refer to Setting the Engineering Units Section) and if the input is set for unidirectional or bidirectional (Refer to the Setting for Unidirectional or Bidirectional Section). The tables below show the maximum full scale value for the selected range and selected units. If the unit is set to unidirectional, the ranges are all zero based. If the unit is set for bidirectional, the ranges will be  $\pm$  the maximum full scale value shown in the tables below.

DIP Switch		Full Scale Range for MS2-X101			
1	2	in w.c.	Pa	mm w.c.	kPa
OFF	OFF	0.1	25	2.5	0.025
OFF	ON	0.15	40	4	0.040
ON	OFF	0.25	50	6	0.050
ON	ON	0.5	125	10	0.125

DIP Switch		Full Scale Range for MS2-X102			
1	2	in w.c.	Pa	mm w.c.	kPa
OFF	OFF	1	250	25	0.250
OFF	ON	2	500	50	0.500
ON	OFF	3	750	75	0.750
ON	ON	5	1250	125	1.25

DIP Switch		Full Scale Range for MS2-X103			
1	2	in w.c.	Pa	mm w.c.	kPa
OFF	OFF	10	2500	250	2.50
OFF	ON	15	3500	350	3.50
ON	OFF	25	5000	500	5.00
ON	ON	28	6975	700	6.98

### Setting for Unidirectional or Bidirectional

The Models MS2-X101 and MS2-X102 models are unidirectional only. The Bidirectional models MS2-X103, MS2-X111 and MS2-X112 can be changed to measure pressure in one direction at a reduced accuracy by changing the setting of DIP Switch 3.

- When the switch is in the ON direction, the transmitter will be set for Unidirectional and will be 0 based (i.e. 0 to 5 in w.c.).
- When the switch is in the OFF position, the transmitter will be set for Bidirectional and will be  $\pm$  the maximum of the selected range (i.e.  $\pm 5$  in w.c.).
- For unidirectional units only, switch has no effect and unit will remain in unidirectional mode.

### Setting the Engineering Units

Magnesense® II comes with the selection of four engineering units (in w.c., Pa, mm w.c., or kPa). The engineering units are selected using DIP Switch 4 and 5. The units will be displayed on the optional LCD display.

DIP Switch		Units		
4	5	Pressure	Velocity	Air Flow
OFF	OFF	kPa	m/s	m <sup>3</sup> /h
OFF	ON	mm w.c.	m/s	m <sup>3</sup> /h
ON	OFF	Pa	m/s	m <sup>3</sup> /h
ON	ON	in w.c.	FPM	cfm

### Setting the Output Voltage Range

Voltage output can be either 0 to 10 V or 0 to 5 V depending on the position of DIP Switch 6.

- When the switch is in the ON position, the output will be 0 to 10 V
- When the switch is in the OFF position, the output will be 0 to 5 V

### Setting the Input / Output Action

The output will either directly or indirectly follow the input based on the position of DIP Switch 7.

- When the switch is in the ON position, the output directly follows the input (i.e. output increases as the input increases)
- When the switch is in the OFF position, the output acts in reverse of the input (i.e. output decreases as the input increases)

### CALIBRATION

#### NOTICE

There is a 5 second delay from the time the zero or span calibration buttons is released until the time that the change in calibration takes place. This delay is used to prevent stress related offsets on the lower ranges.

#### NOTICE

The security level that is set in the Programming Menu Section of the manual will determine which calibrations, if any, may be adjusted by the user.

#### Zero Calibration

The zero calibration can be set by applying zero pressure to both the pressure ports and pressing the zero button for 3 seconds. If either the remote or local LCD is present, the display will read  $Z_{Er0}$  and then sequence back to the home display.

#### SPAN Calibration

The span calibration can be adjusted only after setting the zero adjustment. It must be completed within 5 minutes of the last zero calibration. The span calibration button will be ignored until the zero calibration is completed. Apply pressure to the ports of the transmitter that is associated with the maximum output of the transmitter (20 mA, 5 V, or 10 V depending on output being used). Press and hold the span button for 3 seconds. If either the remote or local LCD is present, the display will read  $S_{Pn7}$  and then sequence back to the home display. If the span calibration is attempted before adjusting the zero calibration, the  $F_{Rl}$  error message will flash on the display. On bi-directional models, separate spans can be performed on the positive and negative sides of the range.

#### LCD DISPLAY

The Magnesense® II can be ordered with an optional, integral LCD. If the display is not needed for normal operation, the transmitter can be ordered without the LCD. An A-MS2-LCD field upgradeable display is available. It comes with a housing cover with the overlay cut out for the display. The display will plug into the pins as shown in Figure 6.

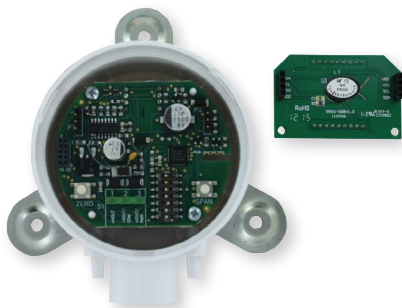

Figure 6

Another option for models that do not have a display would be to use a Model A-435-A remote display tool which can plug into the connector shown in Figure 7. The remote display tool has two buttons that function identically to the buttons on the PCB.



Figure 7

### Display Error Messages

$ovEr$  = The applied pressure is greater than the maximum span value causing an Over Range Error.

$UndEr$  = The applied pressure is less than the minimum span value causing an Under Range Error.

$F_{Rl}$  = When the span or zero buttons are pressed, the pressure value is out of the range to allow a correct setting. This may be due to a sensor failure or incorrect pressure being applied.

$E_{rr1}$  = The sensor is damaged.

### PROGRAMMING MENUS

#### Home Menu

During normal operation, the display will be in the Home Menu and will display the current measured pressure and the engineering units.

#### Menu Access Security

While in the Home Menu, press and hold the Zero and Span buttons simultaneously until  $SECUR$  appears on the display in order to access the other programming menus. Upon releasing the buttons, the display will indicate the current security level.

If the current security level is the security level desired (i.e. Security Level 0), press and hold the span button for three seconds to enter the Pressure, Velocity, or Air Flow Menu.

If the security level is not the desired level, the security level can be changed temporarily to a lower security level or permanently to a higher level of security by pressing the zero button. A security code will be shown on the display and it can be changed to one of the codes listed in the below table. The span button chooses which digit and the zero button increments the value of that digit. Pressing and holding the span button will store the value.

Security Level	Setting	Access			
		View Menu	Edit Menu	Span	Zero
0	000	Yes	Yes	Yes	Yes
1	111	Yes	No	No	Yes
2	222	No	No	No	Yes
3	333	No	No	No	No

The level of access to the programming menus and the calibration is limited based on the security level. The above table details the level of access for each security level.

### Mode Selection / Digital Dampening Menu

From the home display, pressing the span and zero button simultaneously for 3 seconds will access the Menu Security Level. If the level is set to 0 or 1, pressing and holding the span button for 3 seconds a second time will access the Mode Selection Menu. The display will default to Pressure when first powered up. Pressing the zero button will cycle to Velocity and Flow.

Once the desired Mode is displayed, pressing and holding the span button for three seconds will save the selected mode and display the digital dampening or averaging parameter. This parameter stabilizes the output and the display by averaging the readings. There are 2.5 readings taken each second and the user can select the number of seconds that they would like to average up to 240 seconds. The display and the output will continue to update at a rate of 2.5 updates per second, but the moving average is used for these updates.

### PRESSURE MODE

#### Maximum Output Adjustment

If the Pressure Mode was selected, pressing and holding the span after adjusting the digital dampening will enter the Pressure Mode. In this menu, the maximum output pressure (POH) can be adjusted to any pressure between the lowest dip switch range to the highest dip switch range. If the dip switch settings are preferred over manually setting the range, the POH parameter can be set to off.

### VELOCITY MODE

#### K-Factor Adjustment

If the Velocity Mode was selected, pressing and holding the span after adjusting the digital dampening will enter the Velocity Mode and the transmitter will display the engineering unit that has been selected by the dip switch. Pressing and holding the span button for three seconds will enter the K – Factor adjustment. The K – Factor can be adjusted between 0.001 to 9.999. The K-Factor can be adjusted by pressing the span button to select the digit and pressing the zero button to increment the value of the digit. Pressing and holding the span button for three seconds will enter the Maximum Output Adjustment parameter.

#### Maximum Output Adjustment

The maximum output can be equivalent to a velocity or a pressure. After adjusting the K-Factor, the display will indicate if the adjustment is set for pressure or velocity. Pressing the zero button will toggle between the selections. Pressing and holding the span button for three seconds will enter the maximum output adjustment. The maximum output can be adjusted by pressing the span button to select the digit and pressing the zero button to increment the value of the digit. Pressing and holding the span button for three seconds will save this value and go to the Security Update Menu.

### FLOW MODE

#### K-Factor Adjustment

If the Flow Mode was selected, pressing and holding the span after adjusting the digital dampening will enter the Flow Mode and the transmitter will display the engineering unit that has been selected by the dip switch. Pressing and holding the span button for three seconds will enter the K – Factor adjustment. The K – Factor can be adjusted between 0.001 to 9.999. The K-Factor can be adjusted by pressing the span button to select the digit and pressing the zero button to increment the value of the digit. Pressing and holding the span button for three seconds will enter the Area Adjustment parameter.

#### Area Adjustment

For Flow applications, the area is multiplied by the velocity to determine the volumetric air flow. The area will be listed in either feet or meters depending on the dip switch settings. The units will be indicated on the display at the time of adjustment. The area can be adjusted by pressing the span button to select the digit and pressing the zero button to increment the value of the digit. Pressing and holding the span button for three seconds will enter the Maximum Output Adjustment parameter.

#### Maximum Output Adjustment

The maximum output can be equivalent to a flow or a pressure. After adjusting the Area parameter, the display will indicate if the adjustment is set for pressure or flow. Pressing the zero button will toggle between the selections. Pressing and holding the span button for three seconds will enter the maximum output adjustment. The maximum output can be adjusted by pressing the span button to select the digit and pressing the zero button to increment the value of the digit. Pressing and holding the span button for three seconds will save this value and go to the Security Update Menu.

### Security Update / Save Changes Menu

The Security Update Menu allows the security level to be set either higher or lower than the current security level setting. This security level will be displayed the next time the Menus are accessed from the home screen. Pressing the zero button cycles through the security levels. Pressing and holding the span button for three seconds accepts the new security level and gives the option to save all the menu changes. Pressing the zero button will toggle between yes and no. Yes will save the changes made to all menu items and no will discard all the changes made to all menu items. If the display is set to yes, pressing and holding the span will save the menu items and return the display to the Home Position.

### FACTORY DEFAULT PROCEDURE

In order to reset all of the menu settings back to their factory programmed values, press and hold both the span and zero buttons simultaneously for 10 seconds until FRC+ is displayed on the LCD. Upon releasing the buttons, the unit will be factory defaulted. Since resetting the transmitter will wipe out all changes, it is necessary to zero (and possibly span) the transmitter before taking measurements.

### MAINTENANCE/REPAIR

Upon final installation of the Series MS2 Magnesense®II Differential Pressure Transmitter, no routine maintenance is required besides zeroing the transmitter occasionally. Besides routine calibration and installation of the LCD, the Series MS2 is not field serviceable and it is not possible to repair the unit. Field repair should not be attempted and may void warranty.

### WARRANTY/RETURN

Refer to "Terms and Conditions of Sales" in our catalog and on our website. Contact customer service to receive a Return Goods Authorization number before shipping the product back for repair. Be sure to include a brief description of the problem plus any additional application notes.

### APPENDIX I

#### Air Velocity / Air Flow Calculations

Velocity is calculated using the below equation:

$$\text{Velocity (fpm)} = \text{K-Factor} \times 4004.4 \times \sqrt{(\text{Diff. Press. (in of w.c.)})}$$

Velocity in m/s is then calculated from the equation:

$$\text{Velocity (m/s)} = \text{Velocity (fpm)} \times 0.00508$$

Flow is calculated using the below equation:

$$\text{Flow (cfm)} = \text{Area (Ft}^2\text{)} \times \text{K-Factor} \times 4004.4 \times \sqrt{(\text{Diff. Press. (in of w.c.)})}$$

$$\text{Flow (m}^3\text{/h)} = \text{Flow (cfm)} \times 1.6992$$





### APPENDIX II

#### Maximum Flow

Range in w.c.	Max Displayed Flow		Max (K Factor x Area)	
	CFM	M <sup>3</sup> /H	CFM Mode	M <sup>3</sup> /H Mode
0.5	5885000	9999000	2037.2	154.5
5	5885000	9999000	644.2	59.9
28	5885000	9999000	272.2	25.3



MENU FLOW CHART

BUTTON PRESS LEGEND

-  = PRESS ZERO BUTTON
-  = PRESS SPAN BUTTON
-  = PRESS AND HOLD ZERO BUTTON
-  = PRESS AND HOLD SPAN BUTTON
-  = PRESS AND HOLD ZERO AND SPAN BUTTONS





MENU CONVENTIONS

IN HOME POSITION:

-  CALIBRATE UNIT TO ZERO PRESSURE. } DISPLAY IS NOT NECESSARY
-  CALIBRATE UNIT TO SPAN PRESSURE. } DISPLAY IS NOT NECESSARY

-  ENTER MENU DISPLAY

IN MENU DISPLAY:

-  SEQUENCES TO NEXT MAIN MENU ITEM, AND IF A MENU ITEM IS CHANGED TEMPORARILY SAVES THE SELECTION
-  SEQUENCES THROUGH SUB MENU SELECTIONS OR INCREMENTS DIGITS
-  SEQUENCE TO NEXT DIGIT. ACTIVE DIGIT WILL BLINK.  = BLINKING DIGIT

