

AC 24 V / DC 24 V

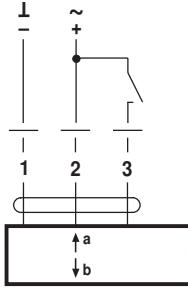

..V(C)24A



AC 230 V

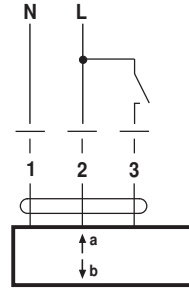

..V(C)230A

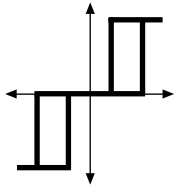

AC 24 V / DC 24 V

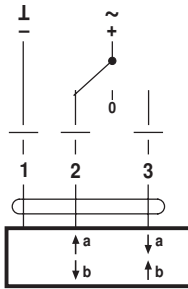

..V(C)24A



AC 230 V

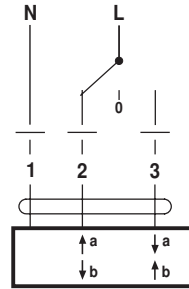

..V(C)230A

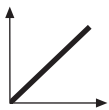

AC 24 V / DC 24 V

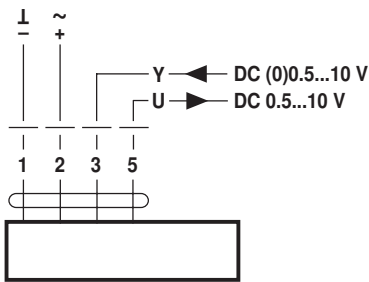

..V(C)24A-SZ

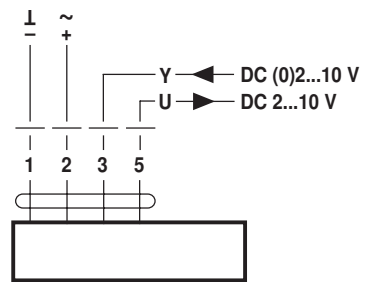

..V(C)24A-SR

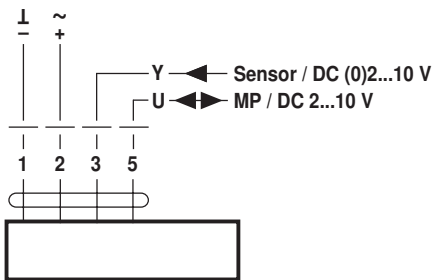

..V(C)24A-MP

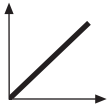

AC 24 V / DC 24 V

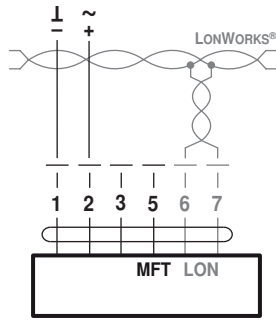

..V24ALON

BACnet MS/TP / Modbus RTU

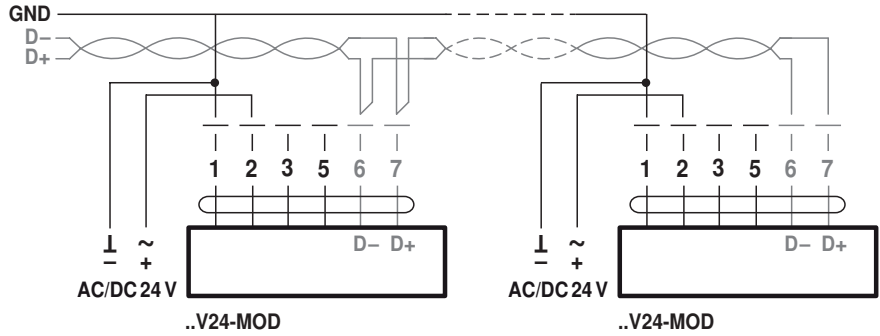

..V24-MOD

..V24-MOD

BACnet MS/TP / Modbus RTU

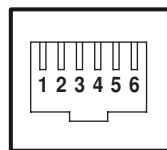

- 1 AC/DC 24 V
- 2 GND
- 3 D- (A)
- 4 D+ (B)
- 5 AC/DC 24 V
- 6 GND

..M24A-MOD-J6

BACnet MS/TP / Modbus RTU / analog

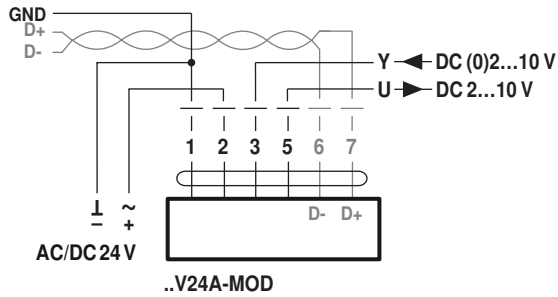

..V24A-MOD

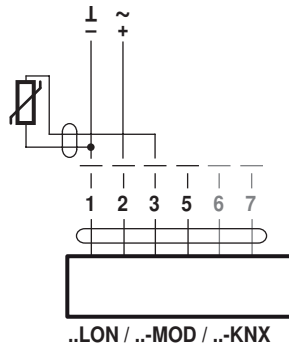

Ni1000	-28...+98°C	850...1600 Ω ²⁾
PT1000	-35...+155°C	850...1600 Ω ²⁾
NTC	-10...+160°C ¹⁾	200 Ω...60 kΩ ²⁾

